



# Use & Care

G U I D E

## Self-Cleaning Electric Ranges

A Note to You .....	2
Range Safety .....	3
Parts and Features....	6
Using Your Range ....	8
Using the Self-Cleaning Cycle .....	26
Caring for Your Range .....	29
Troubleshooting .....	36
Requesting Assistance or Service .....	38
Index .....	39
Warranty .....	40

**1-800-253-1301**

Call our Consumer Assistance Center with questions or comments.



### *Super Capacity 465*

4.65 Cubic Foot Oven

MODELS RF370PXG RF370LXG RF374PXG RF376LXG

8053398

[www.whirlpool.com](http://www.whirlpool.com)

# A NOTE TO YOU

**Thank you for buying a WHIRLPOOL® appliance.**

The Whirlpool Brand is committed to designing quality products that consistently perform for you to make your life easier. To ensure that you enjoy years of trouble-free operation, we developed this Use and Care Guide. It is full of valuable information about how to operate and maintain your appliance properly and safely. Please read it carefully.

Also, please complete and mail the **Product Registration Card** provided with your appliance. The card helps us notify you about any new information on your appliance.

## **Please record your model's information.**

Whenever you call to request service for your appliance, you need to know your complete model number and serial number. You can find this information on the model and serial number label/plate (see diagram in the "Parts and Features" section).

Please also record the purchase date of your appliance and your dealer's name, address, and telephone number.

Model Number \_\_\_\_\_  
Serial Number \_\_\_\_\_  
Purchase Date \_\_\_\_\_  
Dealer Name \_\_\_\_\_  
Dealer Address \_\_\_\_\_  
Dealer Phone \_\_\_\_\_

**Keep this book and the sales slip together in a safe place for future reference. It is important for you to save your sales receipt showing the date of purchase. Proof of purchase will assure you of in-warranty service.**

**Our Consumer Assistance Center number is toll free.**

**1-800-253-1301**

To find detailed product information, the location of the nearest Whirlpool dealer or authorized servicer, to purchase an accessory item, or register your appliance on-line, please visit our Web site at  
**[www.whirlpool.com](http://www.whirlpool.com)**

# RANGE SAFETY

## Your safety and the safety of others is very important.

We have provided many important safety messages in this manual and on your appliance. Always read and obey all safety messages.



This is the safety alert symbol.

This symbol alerts you to hazards that can kill or hurt you and others.

All safety messages will be preceded by the safety alert symbol and the word "DANGER" or "WARNING." These words mean:

**! DANGER**

You **will** be killed or seriously injured if you don't follow instructions.

**! WARNING**

You **can** be killed or seriously injured if you don't follow instructions.

All safety messages will identify the hazard, tell you how to reduce the chance of injury, and tell you what can happen if the instructions are not followed.

## **! WARNING**



### Tip Over Hazard

A child or adult can tip the range and be killed.

Connect anti-tip bracket to rear range foot.

Reconnect the anti-tip bracket, if the range is moved.

See the installation instructions for details.

Failure to follow these instructions can result in death or serious burns to children and adults.

### Anti-Tip Bracket

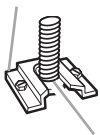

Range Foot

Making sure the anti-tip bracket is installed:

- Slide range forward.
- Look for the anti-tip bracket securely attached to floor.
- Slide range back so rear range foot is under anti-tip bracket.

continued on next page

## IMPORTANT SAFETY INSTRUCTIONS

**WARNING:** To reduce the risk of fire, electrical shock, injury to persons, or damage when using the range, follow basic precautions, including the following:

- **WARNING – TO REDUCE THE RISK OF TIPPING OF THE RANGE, THE RANGE MUST BE SECURED BY PROPERLY INSTALLED ANTI-TIP DEVICES. TO CHECK IF THE DEVICES ARE INSTALLED PROPERLY, SLIDE RANGE FORWARD, LOOK FOR ANTI-TIP BRACKET SECURELY ATTACHED TO FLOOR, AND SLIDE RANGE BACK SO REAR RANGE FOOT IS UNDER ANTI-TIP BRACKET.**
- **CAUTION –** Do not store items of interest to children in cabinets above a range or on the backguard of a range – children climbing on the range to reach items could be seriously injured.
- Proper Installation – Be sure the range is properly installed and grounded by a qualified technician.
- Never Use the Range for Warming or Heating the Room.
- Do Not Leave Children Alone – Children should not be left alone or unattended in area where the range is in use. They should never be allowed to sit or stand on any part of the range.
- Wear Proper Apparel – Loose-fitting or hanging garments should never be worn while using the range.
- User Servicing – Do not repair or replace any part of the range unless specifically recommended in the manual. All other servicing should be referred to a qualified technician.
- Storage in or on the Range – Flammable materials should not be stored in an oven or near surface units.
- Do Not Use Water on Grease Fires – Smother fire or flame or use dry chemical or foam-type extinguisher.
- Use Only Dry Potholders – Moist or damp potholders on hot surfaces may result in burns from steam. Do not let potholder touch hot heating elements. Do not use a towel or other bulky cloth.
- DO NOT TOUCH SURFACE UNITS OR AREAS NEAR UNITS – Surface units may be hot even though they are dark in color. Areas near surface units may become hot enough to cause burns. During and after use, do not touch, or let clothing or other flammable materials contact surface units or areas near units until they have had sufficient time to cool. Among those areas are the cook-top and surfaces facing the cook-top.
- Use Proper Pan Size – The range is equipped with one or more surface units of different size. Select utensils having flat bottoms large enough to cover the surface unit heating element. The use of undersized utensils will expose a portion of the heating element to direct contact and may result in ignition of clothing. Proper relationship of utensil to burner will also improve efficiency.
- Never Leave Surface Units Unattended at High Heat Settings – Boilover causes smoking and greasy spillovers that may ignite.
- Make Sure Reflector Pans or Drip Bowls Are in Place – Absence of these pans or bowls during cooking may subject wiring or components underneath to damage.
- Protective Liners – Do not use aluminum foil to line surface unit drip bowls or oven bottoms, except as suggested in the manual. Improper installation of these liners may result in a risk of electric shock, or fire.
- Glazed Cooking Utensils – Only certain types of glass, glass/ceramic, ceramic, earthenware, or other glazed utensils are suitable for range-top service without breaking due to the sudden change in temperature.
- Utensil Handles Should Be Turned Inward and Not Extend Over Adjacent Surface Units – To reduce the risk of burns, ignition of flammable materials, and spillage due to unintentional contact with the utensil, the handle of a utensil should be positioned so that it is turned inward, and does not extend over adjacent surface units.
- Do Not Soak Removable Heating Elements – Heating elements should never be immersed in water.

– SAVE THESE INSTRUCTIONS –

## IMPORTANT SAFETY INSTRUCTIONS

- Do Not Cook on Broken Cook-Top – If cook-top should break, cleaning solutions and spillovers may penetrate the broken cook-top and create a risk of electric shock. Contact a qualified technician immediately.
- Clean Cook-Top With Caution – If a wet sponge or cloth is used to wipe spills on a hot cooking area, be careful to avoid steam burn. Some cleaners can produce noxious fumes if applied to a hot surface.
- Use Care When Opening Door – Let hot air or steam escape before removing or replacing food.
- Do Not Heat Unopened Food Containers – Build-up of pressure may cause container to burst and result in injury.
- Keep Oven Vent Ducts Unobstructed.
- Placement of Oven Racks – Always place oven racks in desired location while oven is cool. If rack must be moved while oven is hot, do not let potholder contact hot heating element in oven.
- DO NOT TOUCH HEATING ELEMENTS OR INTERIOR SURFACES OF OVEN – Heating elements may be hot even though they are dark in color. Interior surfaces of an oven become hot enough to cause burns. During and after use, do not touch, or let clothing or other flammable materials contact heating elements or interior surfaces of oven until they have had sufficient time to cool. Other surfaces of the appliance may become hot enough to cause burns – among these surfaces are oven vent openings and surfaces near these openings, oven doors, and windows of oven doors.

### For self-cleaning ranges –

- Do Not Clean Door Gasket – The door gasket is essential for a good seal. Care should be taken not to rub, damage, or move the gasket.
- Do Not Use Oven Cleaners – No commercial oven cleaner or oven liner protective coating of any kind should be used in or around any part of the oven.
- Clean Only Parts Listed in Manual.
- Before Self-Cleaning the Oven – Remove broiler pan and other utensils.

### For units with ventilating hood –

- Clean Ventilating Hoods Frequently – Grease should not be allowed to accumulate on hood or filter.
- When flaming foods under the hood, turn the fan off. The fan, if operating, may spread the flame.

– SAVE THESE INSTRUCTIONS –

# PARTS AND FEATURES

(Models RF370PXG and RF370LXG)

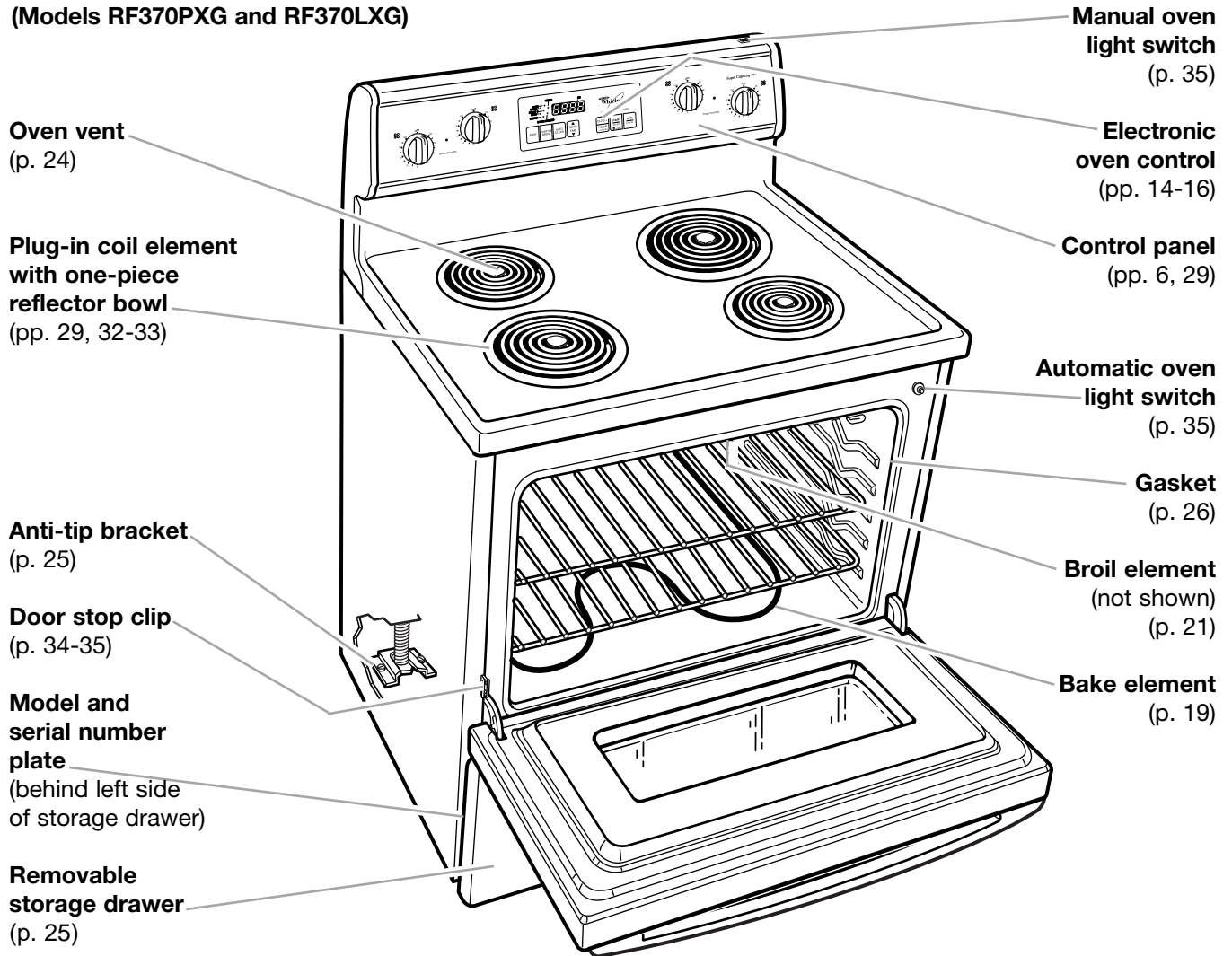

## CONTROL PANEL

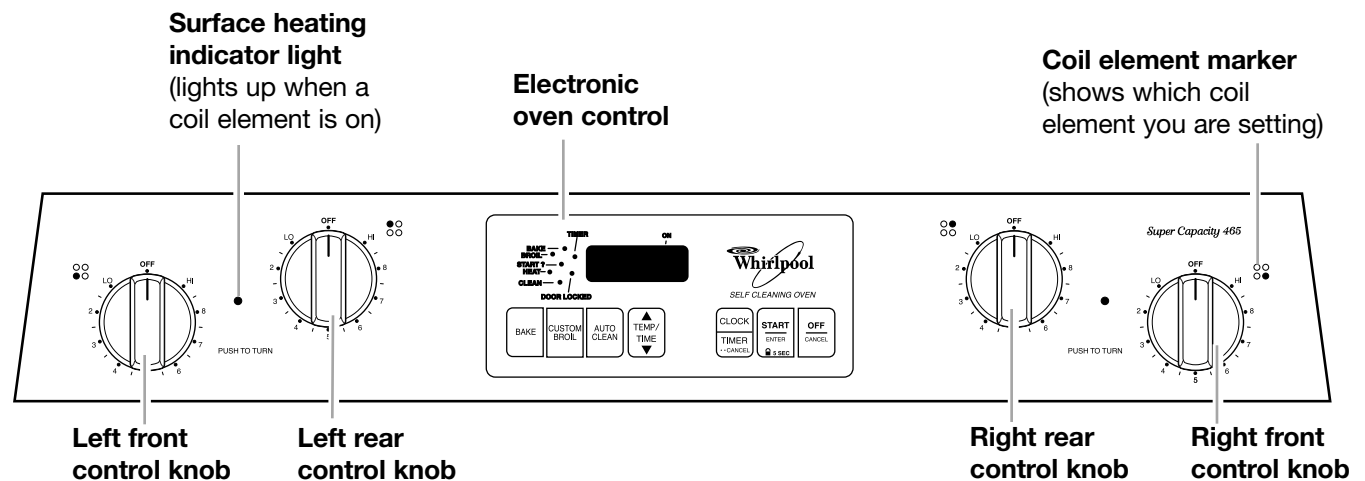

(Model RF374PXX shown)  
(Model RF376LXX not shown)

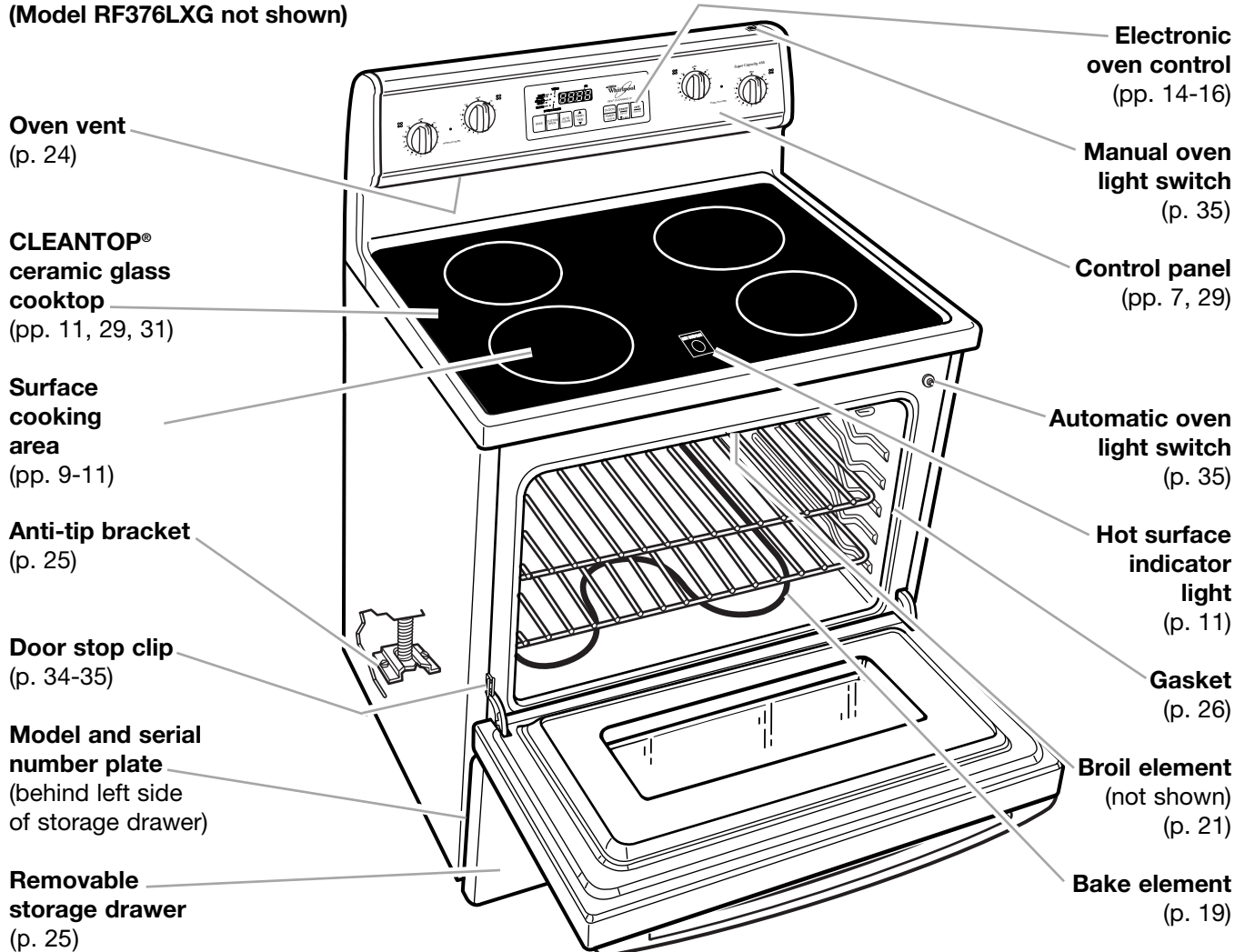

## CONTROL PANEL

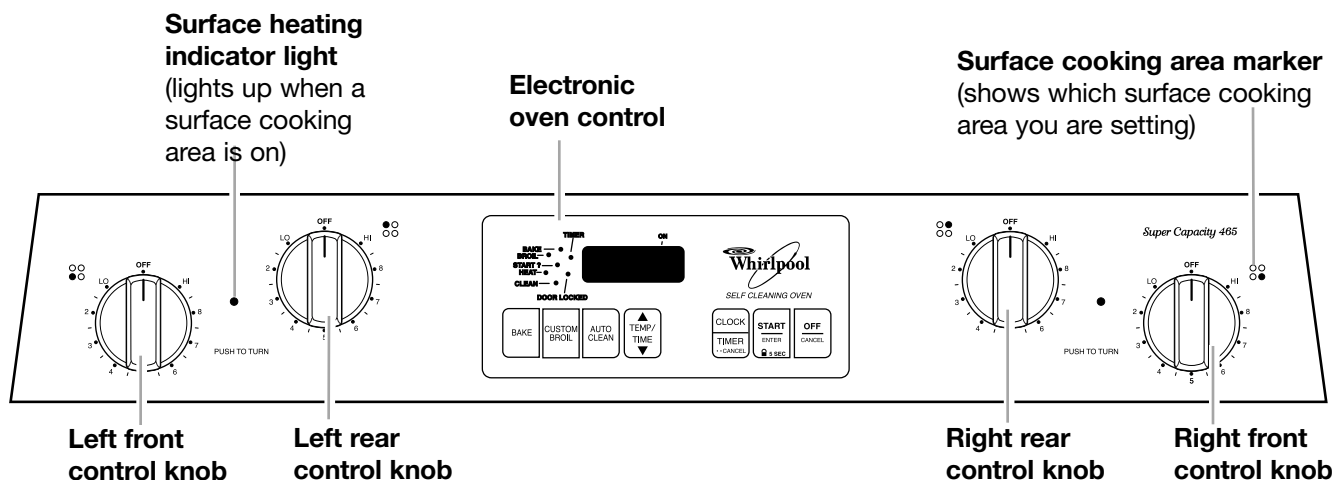

# USING YOUR RANGE

## USING THE SURFACE COOKING AREAS

### Using the control knobs

Push in the control knobs before turning them to a setting. You can set them anywhere between HI and OFF.

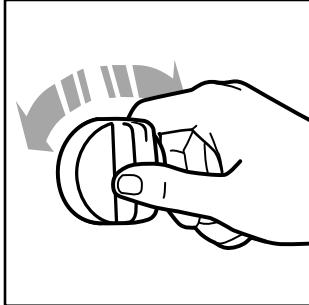

### Surface cooking area heat settings

Use the following chart as a guide.

SETTING	RECOMMENDED USE
HI	<ul style="list-style-type: none"><li>● To start food cooking.</li><li>● To bring liquid to a boil.</li></ul>
6-8	<ul style="list-style-type: none"><li>● To hold a boil.</li><li>● To quickly brown or sear food.</li></ul>
5	<ul style="list-style-type: none"><li>● To maintain a slow boil.</li><li>● To fry poultry or meat.</li><li>● To make pudding, sauce, or gravy.</li></ul>
2-4	<ul style="list-style-type: none"><li>● To stew or steam food.</li><li>● To simmer food.</li></ul>
LO	<ul style="list-style-type: none"><li>● To keep food warm.</li></ul>

## ⚠ WARNING



### Fire Hazard

**Turn off all controls when done cooking.  
Failure to do so can result in death or fire.**

### Easy ways to save energy

- To help shorten your cooking time, use the least amount of liquid possible.
- Preheat your pots and pans only when recommended and for the shortest time possible.
- Start your food on a higher heat setting, then turn the control to a lower setting to finish cooking.

## USING THE SURFACE COOKING AREAS (CONT.)

### Home canning information

#### To protect your range:

- Use flat-bottomed canners on all types of cooktops, especially ceramic glass. Canners with rippled or ridged bottoms do not allow good contact with the surface.
- Center the canner over the largest surface cooking area. Do not extend more than one inch outside the surface

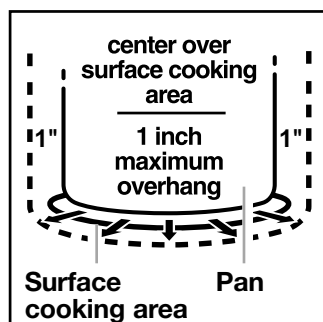

cooking area. Large diameter canners/pans, if not centered correctly, trap heat and can cause damage to the cooktop.

- Do not place your canner on two surface cooking areas at the same time.
- The type of material the canner is made of determines the length of heating time. Refer to the "Characteristics of cookware materials" chart later in this section for more information.
- When canning for long periods of time, allow elements and the surrounding surfaces to cool down.

- Alternate use of the surface cooking areas between batches or prepare small batches at a time.
- Start with hot water, cover with a lid, and bring to a boil; then reduce heat to maintain a boil or required pressure levels in a pressure canner.
- On coil element model, keep your reflector bowls clean so that they will always reflect heat well.
- For up-to-date information on canning, contact your local U.S. Government Agricultural Department Extension Office or companies who manufacture home canning products.

### Optional canning kit

#### (Coil element model)

Most water-bath or pressure canners have large diameters. If you do canning with them at high heat settings for long periods of time, you can shorten the life of regular coil elements. This can also damage the cooktop. If you plan to use the cooktop for canning, we recommend the installation of a Canning Kit. Order the kit (Part No. 242905) from your dealer or authorized service company.

continued on next page

## USING THE SURFACE COOKING AREAS (CONT.)

### Cookware tips

- **Select a pan** that is about the same size as the surface cooking area. Cookware should not extend more than 1 inch (2.5 cm) outside the area.
- **For best results and greater energy efficiency**, use only flat-bottomed cookware that makes good contact with the surface cooking area. Cookware with rounded, warped, ribbed (such as some porcelain enamelware), or dented bottoms could cause uneven heating and poor cooking results.
- **Cookware designed** with slightly indented bottoms or small expansion channels can be used.
- **Cookware with a non-stick finish** has heating characteristics of the base material.
- **Check for rough spots** on the bottom of metal or glass cookware which will scratch the ceramic glass surface.
- **Use flat bottom cookware** for best heat conduction from the surface cooking area to the cookware. Determine flatness with the ruler test. Place the edge of a ruler across the bottom of the cookware. Hold it up to the light. No light should be visible under the ruler. Rotate the ruler in all directions and look for any light.
- **Do not leave** empty cookware, or cookware which has boiled dry, on a hot surface cooking area. The cookware could overheat, causing damage to the cookware or the surface cooking area.

## CHARACTERISTICS OF COOKWARE MATERIALS

The pan material affects how fast heat transfers from the surface cooking area through the pan material and how evenly heat spreads over the pan bottom. Choose pans that provide the best cooking results.

Aluminum	<ul style="list-style-type: none"> <li>• Heats quickly and evenly.</li> <li>• Use for all types of cooking.</li> <li>• Medium or heavy thickness is best for most cooking.</li> <li>• Used as a core or base in cookware to provide even heating.</li> </ul>
Cast iron	<ul style="list-style-type: none"> <li>• Heats slowly and evenly.</li> <li>• Good for browning and frying.</li> <li>• Maintains heat for slow cooking.</li> <li>• Can be coated with porcelain enamel.</li> </ul>
Ceramic or ceramic glass	<ul style="list-style-type: none"> <li>• Heats slowly and unevenly.</li> <li>• Use on low to medium settings.</li> <li>• Follow manufacturer's instructions.</li> </ul>
Copper	<ul style="list-style-type: none"> <li>• Heats very quickly and evenly.</li> <li>• Used as a core or base in cookware to provide even heating.</li> </ul>
Earthenware	<ul style="list-style-type: none"> <li>• Can be used for cooktop cooking if recommended by the manufacturer.</li> <li>• Use on low settings.</li> </ul>
Porcelain enamel-on-steel or enamel-on-cast iron	<ul style="list-style-type: none"> <li>• See cast iron and stainless steel.</li> </ul>
Stainless steel	<ul style="list-style-type: none"> <li>• Heats quickly but unevenly.</li> <li>• A core or base of aluminum or copper on the cookware provides even heating.</li> <li>• Can be coated with porcelain enamel.</li> </ul>

# USING THE SURFACE COOKING AREAS (CONT.)

## Using the ceramic glass cooktop

(Model RF376LXG shown)

Cooking on the ceramic glass cooktop is similar

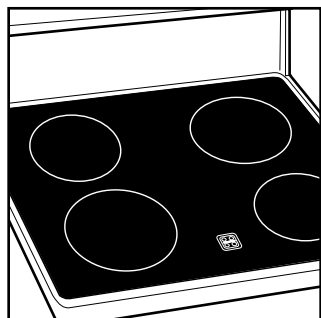

to cooking on coil elements. There are, however, a few differences:

- The surface cooking area will glow red when the element is turned on. You will see the element cycling on and off – even on the HI setting – to help the area stay at the temperature setting you chose.
- Do not cook foods directly on the cooktop.
- Do not cook popcorn that comes in prepackaged aluminum containers on the cooktop. The container could leave aluminum marks on the cooktop that cannot be removed completely.
- Make sure the bottoms of pots and pans are clean and dry before using them. Food and water particles left on the bottoms can leave deposits on the cooktop when it is heated.

- Lift pots and pans onto and off of the cooktop. Sliding pots and pans on the cooktop could leave marks that are difficult to remove or could leave permanent marks.
- Dropping a heavy or hard object on the cooktop could crack it. Be careful when using heavy skillets and large pots. Do not store jars or cans above the cooktop.
- Do not use the cooktop as a cutting board.
- Do not allow anything that could melt, such as plastic, to come in contact with the cooktop while it is hot.
- Sugary spills and soils can cause pitting. See “Cleaning the ceramic glass cooktop” in the “Caring for Your Range” section for more information.
- Wiping off the cooktop before and after each use will help keep the surface free from stains and give you the most even heating. See “Cleaning the ceramic glass cooktop” in the “Caring for Your Range” section for care and cleaning suggestions.

## Hot surface indicator lights

(Model RF376LXG)

One of the hot surface indicator lights on the cooktop will glow when a surface cooking area becomes too hot to touch. The indicator light will continue to glow as long as the surface cooking area is too hot to touch, even after it is turned off.

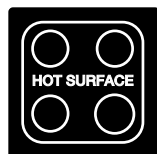

## Hot surface indicator light

(Model RF374PXC)

The hot surface indicator light on the cooktop will glow when a surface cooking area becomes too hot to touch. The indicator light will continue to glow as long as the surface cooking area is too hot to touch, even after it is turned off.

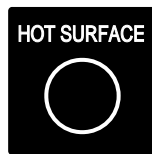

# USING THE OVEN

## Positioning racks and pans

Place the oven racks where you need them before turning on the oven.

- To move a rack, pull it out to the stop position, raise the front edge and lift it out.
- Be sure the rack(s) is level.
- Use pot holders or oven mitts to protect your hands if rack(s) must be moved while the oven is hot.
- For best performance, cook on one rack. Place the rack so the top of the food will be centered in the oven.
- When cooking with two racks, arrange the racks on the 2nd and 4th rack guides. Two sheets of cookies may be baked if sheets are switched at approximately three quarters of the total bake time. Increase baking time, if necessary.
- For best results allow 2 inches of space around each pan and between pans and oven walls.

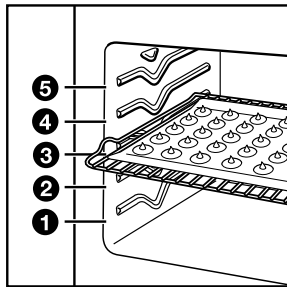

Hot air must circulate around the pans in the oven for even heat to reach all parts of the oven. This results in better baking.

## Where to place pans:

WHEN YOU HAVE	PLACE
1 pan	In center of the oven rack.
2 pans	Side by side or slightly staggered.
3 or 4 pans	In opposite corners on each oven rack. Stagger pans so no pan is directly over another.

## Rack placement for specific foods:

FOOD	RACK POSITION
Frozen pies, large roasts, turkeys, angel food cakes	1st or 2nd rack guide from bottom
Bundt cakes, most quick breads, yeast breads, casseroles, meats	2nd rack guide from bottom
Cookies, biscuits, muffins, cakes, nonfrozen pies	2nd or 3rd rack guide from bottom

**NOTE:** For information on where to place your rack when broiling, see “Broiling guidelines” later in this section.

# BAKEWARE CHOICES

Baking performance is affected by the type of bakeware used. Use the bakeware size recommended in the recipe.

BAKEWARE TYPE	BEST USED FOR	GUIDELINES
Light colored aluminum	<ul style="list-style-type: none"> <li>• Light golden crusts</li> <li>• Even browning</li> </ul>	<ul style="list-style-type: none"> <li>• Use temperature and time recommended in recipe.</li> </ul>
Dark aluminum and other bakeware with dark, dull, and/or non-stick finish	<ul style="list-style-type: none"> <li>• Brown, crisp crusts</li> </ul>	<ul style="list-style-type: none"> <li>• May reduce baking temperature 25°F.</li> <li>• Use suggested baking time.</li> <li>• Use temperature and time recommended in recipe for pies, breads, and casseroles.</li> <li>• Place rack in center of oven.</li> </ul>
Ovenproof glassware, ceramic glass, or ceramic	<ul style="list-style-type: none"> <li>• Brown, crisp crusts</li> </ul>	<ul style="list-style-type: none"> <li>• May reduce baking temperature 25°F.</li> </ul>
Insulated cookie sheets or baking pans	<ul style="list-style-type: none"> <li>• Little or no bottom browning</li> </ul>	<ul style="list-style-type: none"> <li>• Place in the bottom third of oven.</li> <li>• May need to increase baking time.</li> </ul>
Stainless steel	<ul style="list-style-type: none"> <li>• Light, golden crusts</li> <li>• Uneven browning</li> </ul>	<ul style="list-style-type: none"> <li>• May need to increase baking time.</li> </ul>
Stoneware	<ul style="list-style-type: none"> <li>• Crisp crusts</li> </ul>	<ul style="list-style-type: none"> <li>• Follow manufacturer's instructions.</li> </ul>

# USING ALUMINUM FOIL

- Use aluminum foil to catch spillovers from pies or casseroles by placing foil on the oven rack below. Foil should be turned up at edges and be at least 1 inch larger than dish.

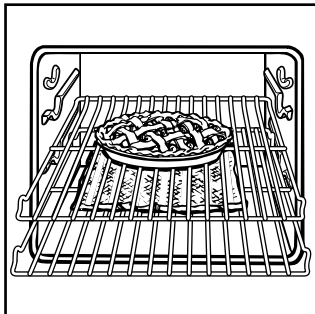

- Do not cover the entire rack with aluminum foil. It will reduce air circulation and give you poor cooking results.

- Do not line the oven bottom with foil or other liners. It could affect the oven surface as well as the quality of your baking.
- Place tent-shaped foil loosely over meat or poultry to slow down surface browning for long term roasting. Remove foil for the last 30 minutes.
- Use narrow strips of foil to shield piecrust edges if browning too quickly.

# THE ELECTRONIC OVEN CONTROL

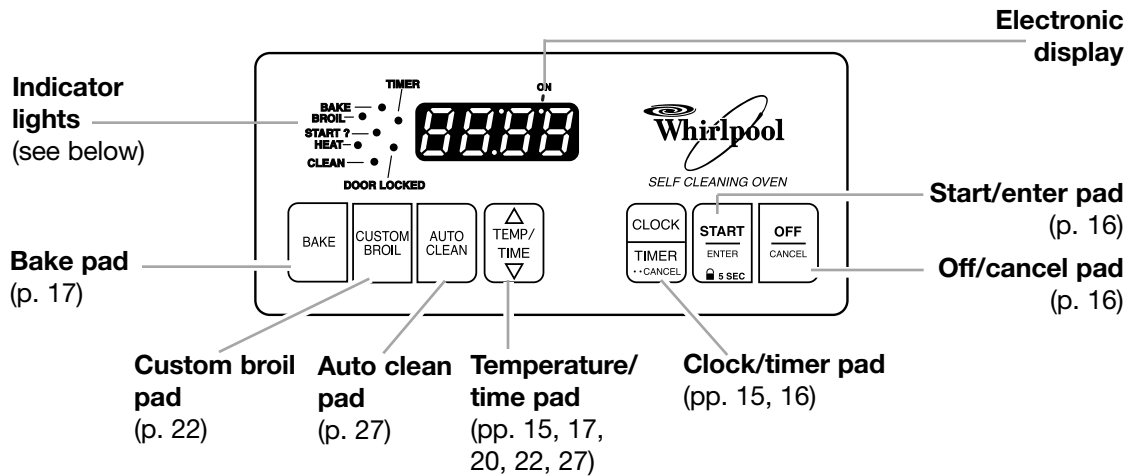

## Display/clock

- When you first plug in the range, “PF” will appear on the display/clock until you press any command pad. If “PF” again appears on the display, your electricity was off for a while.
- When you are using the oven, the display will show preheat times and temperature settings.
- When you are not using the oven, the display shows the time of day.
- When showing the time of day, the display will show the hours and minutes.
- When you are using the minute timer, the display will count down each minute.
- When setting a function, if you do not press START/ENTER within 5 seconds, the Start? indicator light will flash. If you do not press START/ENTER within 5 minutes, the function will be canceled.

## Indicator lights

An indicator light to the left of the display lights up when you are in a setting. An indicator light on the display lights up when the oven is on.

## Using the control lock

The control lock lets you disable the control panel command pads. The control lock comes in handy when you want to prevent others from using the oven.

### NOTES:

- You can only use the control lock when the oven is not in use or the control has not been set.
- Set the control lock when cleaning the control panel to prevent yourself from accidentally turning on the oven.

### To lock the control panel:

Press and hold START/ENTER for 5 seconds.



You will hear a single tone and “Loc” will appear on the temperature display for 5 seconds. “Loc” will then appear whenever a command pad is pressed.

### To unlock the control panel:

Press and hold START/ENTER for 5 seconds.



You will hear a single tone and “Loc” will disappear from the temperature display.

# SETTING THE CLOCK

1. Press CLOCK.

PRESS



YOU SEE



2. Set the time.

Press the “up” (▲) or “down” (▼) pad(s) until the correct time shows on the display.

PRESS



YOU SEE



(example for 5:30)

3. Start the clock.

**NOTES:**

- To see the time of day when the clock time is not on the display, press CLOCK.
- You must reset the clock if the power goes off for more than 1 second.

PRESS

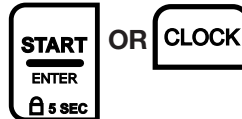

YOU SEE



# USING THE ELECTRONIC MINUTE TIMER

The minute timer does not start or stop the oven. It works like a kitchen timer. It can be set in hours and minutes up to 12 hours, 59 minutes. The minute timer will display minutes and seconds for settings under 1 hour.

1. Press TIMER.

The timer indicator light will light up.

PRESS



YOU SEE



2. Set the interval to be timed.

Press the “up” (▲) or “down” (▼) pad(s) until the correct time shows on the display.

PRESS



YOU SEE



(example for 10 minutes)

## USING THE ELECTRONIC MINUTE TIMER (CONT.)

- 3.** Start the minute timer.  
The minute timer will begin counting down immediately after the timer is started.

**PRESS**



**YOU SEE**



(display counts down)

When the time is up:  
You will hear four 1-second tones.

**NOTE:** To display the time of day while the minute timer is counting down, press CLOCK.

**YOU SEE**



- 4.** To clear the display, turn off the minute timer.

**PRESS**



**YOU SEE**



(time of day)

**To cancel the minute timer during the countdown:**

**PRESS**



(twice)

**YOU SEE**



(time of day)

## STARTING/CANCELING A FUNCTION

After setting a function for the first time, you must press START/ENTER to start the function.



OFF/CANCEL will cancel any function except for the clock, minute timer, or control lock.



# BAKING/ROASTING

**1.** Place the racks where you need them.

For more information, see “Positioning racks and pans” in “Using the oven” earlier in this section.

**NOTE:** Do not place food directly on the oven door or the oven bottom.

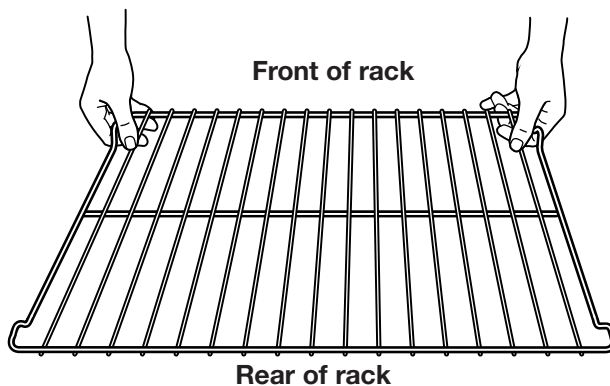

**2.** Choose the bake setting.

The bake indicator light will light up.

PRESS



YOU SEE



**3.** Set the temperature (optional).

Do this step if you want to set a temperature other than 350°F. Press ▲ to raise the temperature or ▼ to lower the temperature in 5°F amounts. You can set a temperature anywhere from 170°F to 500°F. Use these pads until the desired temperature shows on the display.

PRESS



YOU SEE



(example for bake at 375°F)

continued on next page

# BAKING/ROASTING (CONT.)

**4.** When roasting, put your food in the oven.

You do not have to preheat the oven when roasting, unless your recipe recommends it.

### Roasting meats and poultry

- For even cooking, place the meat on a rack in a shallow pan. This keeps the meat out of the drippings and allows the heat to circulate better.
- Use a meat thermometer for the most accurate doneness. Insert it so the tip is in the center of the largest muscle or thickest portion of the meat or poultry. Make sure the thermometer is not touching bone, fat, or the bottom of the pan.

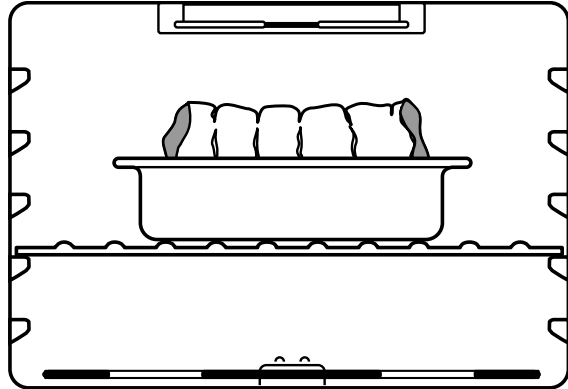

**5.** Press START/ENTER.

A preheat conditioning time counts down the approximate preheat time after the oven temperature has been set and START has been pressed. The heat, bake, and on indicator lights will light up. The oven control automatically sets preheating times based on the oven temperature you select:

- For 245°F and less, the preheating time is 3 minutes.
- For 250°F-445°F, the preheating time is 6 minutes.
- For 450°F and above, the preheating time is 10 minutes.

The oven is preheated and ready to use when you hear a 1-second tone, the on indicator light goes off, the countdown is finished, and the set temperature is displayed.

The preheat and set temperatures may be different at the end of the countdown. This is normal.

**NOTES:**

- When the oven temperature is greater than 170°F, no preheat conditioning time will be shown in the display.
- You can change the temperature setting any time after pressing START/ENTER. You do not have to press START/ENTER again.
- The preheat conditioning time will not change if you reset the temperature before the countdown time ends.
- If you are baking/roasting while the minute timer is counting down, you can see the set baking/roasting temperature for 5 seconds by pressing BAKE.

**PRESS**



**YOU SEE**



(example for set temperature of 325°F)

**YOU SEE**



## BAKING/ROASTING (CONT.)

- 6.** When baking, put your food in the oven after the preheat conditioning time ends.  
During baking/roasting, the elements will turn on and off to keep the oven temperature at the setting.

**NOTE:** The top element helps heat during baking/roasting, but does not turn red.

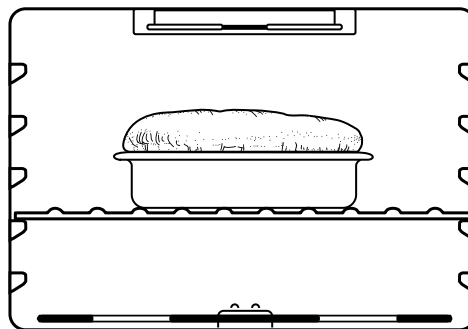

- 7.** After cooking, turn off the oven.

### Saving energy

- To avoid loss of heat, open the oven door as little as possible.
- Use a timer to keep track of cooking time.
- Plan your meals for the most efficient use of the oven by cooking more than one food at a time, or baking while the oven is still hot after cooking a meal.

**PRESS**



**YOU SEE**

(time of day or minute timer countdown)

## ADJUSTING THE OVEN TEMPERATURE CONTROL

Although your new oven is properly adjusted to provide accurate temperatures, it may cook faster or slower than your old oven.

If you are not satisfied with the baking/roasting results, you can change the offset temperature by following the steps below.

- 1.** Press and hold BAKE for 5 seconds.

The display will show the current offset temperature, for example "00," if you have not already adjusted the temperature.

**NOTE:** DO NOT measure the oven temperature with a thermometer. Opening the oven door will lower the oven temperature and give you an incorrect reading. Also, the thermometer temperature reading will change as your oven cycles.

**PRESS**



**YOU SEE**



(factory setting of "0")

# ADJUSTING THE OVEN TEMPERATURE CONTROL (CONT.)

**2. Set the new offset temperature.**

Press ▲ to raise the temperature or ▼ to lower the temperature in 10°F amounts. You can set the temperature change to as low as -30°F or as high as +30°F. A minus (-) sign will appear before the number when decreasing the temperature setting. The minus sign shows the oven will be cooler by the displayed amount. There is no sign in front of the number when increasing the temperature setting.

**PRESS**



**YOU SEE**



(example when making oven 10°F cooler)

**3. Enter the adjustment.**

**NOTE:** The oven control will stay adjusted even after a power failure.

**PRESS**



**YOU SEE**

(time of day or minute timer countdown)

## How to determine the amount of adjustment needed

The chart at the right tells you how much to adjust the offset temperature to get the cooking results you want. You can figure out cooking results by the amount of browning, moistness, and rising times for baked foods.

TO COOK FOOD ...	ADJUST BY THIS NUMBER OF DEGREES (FAHRENHEIT)
A little more	+10
Moderately more	+20
Much more	+30
A little less	-10
Moderately less	-20
Much less	-30

# BROILING

**NOTES:**

- Do not preheat when broiling, unless your recipe recommends it.
- Leave the door partly open whenever you use the oven to broil. This lets the oven stay at the proper temperatures.

**1.** Place the rack where you need it.

You need to place the rack so that the surface of the food is at least 3 inches away from the broil element. See “Broiling guidelines” later in this section.

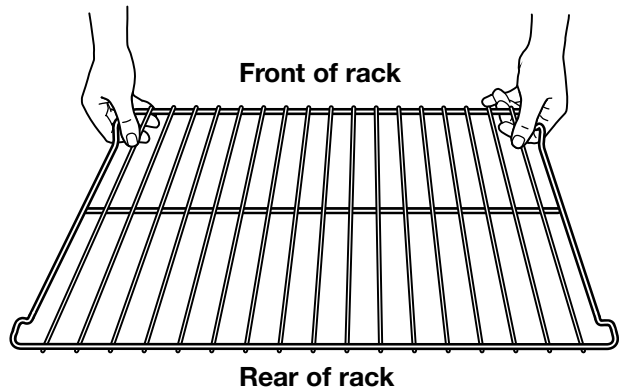

**2.** Put your food on the broiler pan and place the pan in the center of the oven rack.

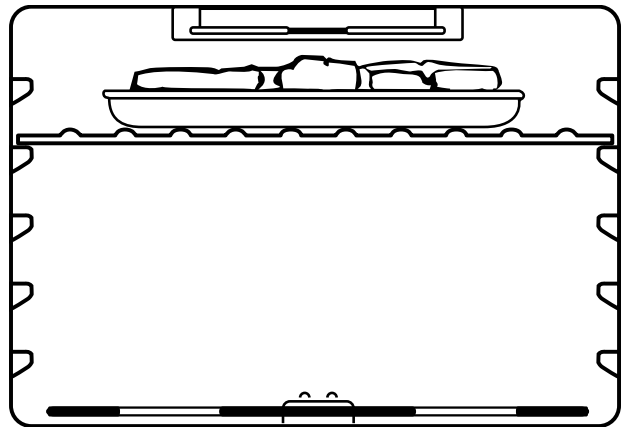

**3.** Close the door to the broil stop position.

The broil stop position lets the door stay open by itself about 5 inches.

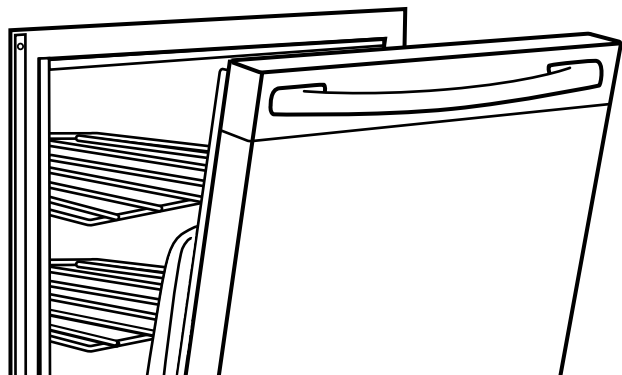

# BROILING (CONT.)

**4.** Press CUSTOM BROIL.

The broil indicator light will light up.

PRESS



YOU SEE



**5.** Start the oven.

The on and heat indicator lights will light up.

PRESS



YOU SEE



**NOTES:**

- You can change the temperature setting any time after pressing START/ENTER. To change the setting, see “To custom broil at a lower temperature” below.
- If you are broiling while the minute timer is counting down, you can see the set broiling temperature for 5 seconds by pressing CUSTOM BROIL.

**6.** After broiling, turn off the oven.

PRESS



YOU SEE



(time of day)

**To custom broil at a lower temperature:**

- If food is cooking too fast, press the ▼ temp pad until “325°F” shows on the display.

PRESS



YOU SEE



(example shows broil at 325°F)

- If you want food to broil slower from the start, press CUSTOM BROIL and press the ▼ temp pad so a temperature between 300°F and 500°F shows on the display. Press START/ENTER.

Lower temperature settings let the broil heating element cycle and slow cooking results. The lower the temperature, the slower the cooking.

**NOTE:** Fish and chicken are some foods that may cook better if you use lower broiling temperatures.

PRESS



YOU SEE



(example shows broil at 400°F)



# BROILING (CONT.)

## Broiling guidelines

- Use only the broiler pan and grid provided. They are designed to drain extra juices from the cooking surface. This drainage helps prevent spatter and smoke.
- To make sure the juices drain well, do not cover the grid with foil.
- Trim excess fat to reduce spattering. Slit the fat on the edges to prevent curling.
- Use tongs to turn meat to avoid losing juices.
- Pull out oven rack to stop position before turning or removing food.
- After broiling, remove the pan from the oven when removing the food. Drippings will bake on the pan if left in the heated oven, making cleaning more difficult.
- For easier cleaning, line the bottom of the pan with aluminum foil. Clean the pan and grid as soon as possible after each use.

Recommended rack positions are numbered from the bottom (1) to the top (5). For best results, place food 3 inches or more from the broil element.

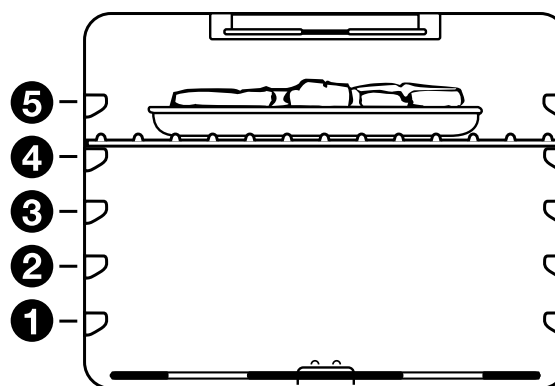

MEAT	RACK POSITION	APPROXIMATE TIME (MINUTES)	
		SIDE 1	SIDE 2
<b>Steak, 1" thick</b>	4		
medium rare		14-15	7-8
medium		15-16	8-9
well done		18-19	9-10
<b>Hamburger Patties, ¾" thick, ¼ lb well done</b>	4	13-14	7-8
<b>Pork Chops, 1" thick</b>	4	20-22	10-11
<b>Ham Slice, ½" thick, precooked</b>	4	8-10	4-5
<b>Frankfurters</b>	4	5-7	3-4
<b>Lamb Chops, 1" thick</b>	4	14-17	8-9
<b>Chicken</b>			
bone-in pieces	3	17-20	17-20
boneless breasts	4	11-16	11-16
<b>Fish</b>	4		
fillets ¼-½" thick		8-10	4-5
steaks ¾-1" thick		16-18	8-9

**NOTE:** Times are guidelines only and may need to be adjusted for individual tastes.

# THE OVEN VENT

## Ceramic glass cooktop model (Models RF374PXC and RF376LXC)

Hot air and moisture escape from the oven through a vent on the backguard below the control panel. The vent lets air circulate properly. Be careful not to block the vent, or you could get poor baking/roasting results.

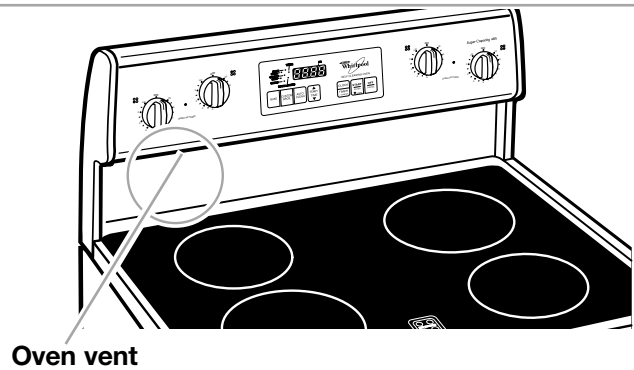

## Coil element model (Models RF370PXC and RF370LXC)

Hot air and moisture escape from the oven through a vent under the left rear coil element. You can cook on this unit or keep food warm on it while the oven is on. The vent is needed for air circulation. **Do not block the vent by using extra large pans or covers.** You will get poor baking/roasting results.

**NOTE:** Never leave plastic utensils over the vent. They could melt.

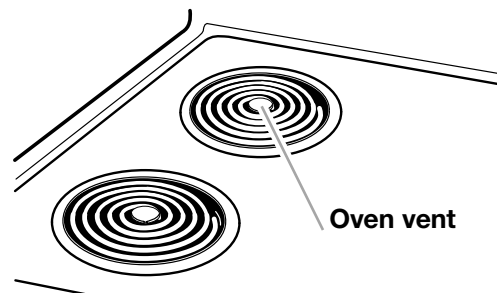

# THE ANTI-TIP BRACKET

The range will not tip during normal use. However, the range can tip if you apply too much force or weight to the open door without the anti-tip bracket fastened down properly.

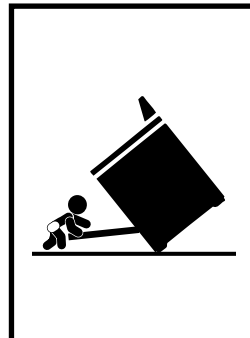

## ⚠️ WARNING

### Tip Over Hazard

**A child or adult can tip the range and be killed.**  
**Connect anti-tip bracket to rear range foot.**  
**Reconnect the anti-tip bracket, if the range is moved.**  
**See the installation instructions for details.**  
**Failure to follow these instructions can result in death or serious burns to children and adults.**

### Anti-Tip Bracket

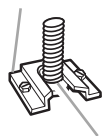

Range Foot

### Making sure the anti-tip bracket is installed:

- Slide range forward.
- Look for the anti-tip bracket securely attached to floor.
- Slide range back so rear range foot is under anti-tip bracket.

# THE STORAGE DRAWER

Use the storage drawer to store cookware. You can remove the drawer to make it easier to clean under the range.

## Removing the storage drawer:

1. Empty the drawer before you remove it. Pull the drawer straight out to the first stop. (The stops are small, round objects formed in the slide rail. They keep the drawer from sliding all the way out.) Then lift the front of the drawer and pull it out to the second stop.
2. Lift the back of the drawer slightly and slide it all the way out.

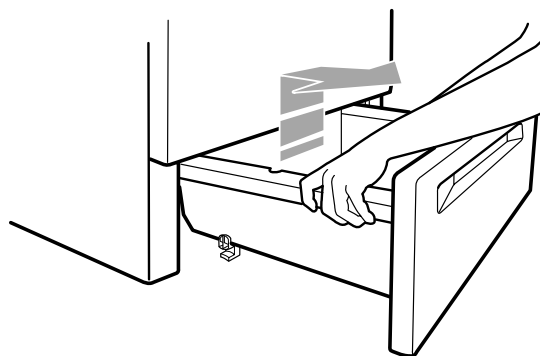

## Replacing the storage drawer:

1. Position the drawer so that the lower drawer guides rest just inside the front frame lip.
2. Lift the front of the drawer and push it in until the metal stops on the drawer slide rails clear the upper drawer guides. Then slide the drawer closed.

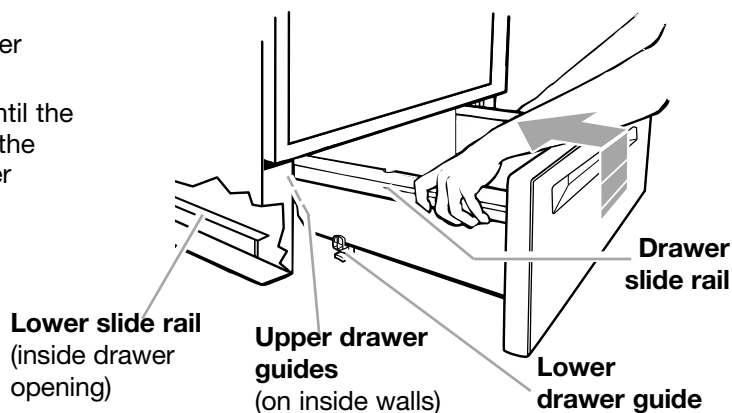

# USING THE SELF-CLEANING CYCLE

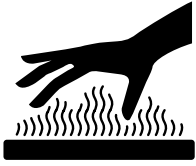

## ⚠ WARNING

### Burn Hazard

Do not touch the oven during the Self-Cleaning cycle.  
Keep children away from oven during Self-Cleaning cycle.  
Do not use commercial oven cleaners in your oven.  
Failure to follow these instructions can result in burns, or illness from inhaling dangerous fumes.

## BEFORE YOU START

**Before you start the Self-Cleaning cycle, make sure you:**

- Hand-clean the areas shown. They do not get hot enough during the Self-Cleaning cycle for soil to burn away. Use hot water and detergent or a soapy, steel-wool pad for cleaning.  
**NOTE:** DO NOT clean, move, or bend the gasket. You may get poor cleaning, baking, and roasting.
  - Do not let water, cleaner, etc., enter slots on door and frame.
  - Remove the broiler pan and grid and any cookware/bakeware being stored in the oven.
  - Wipe out any loose soil or grease. This will help reduce smoke during the Self-Cleaning cycle.
  - Wipe up food spills containing sugar as soon as possible after the oven cools down. When sugar is heated to a high temperature in the Self-Cleaning cycle, the high temperature can cause the sugar to burn and react with the porcelain. This can cause staining and etching or pitting.
  - Remove the oven racks from the oven if you want them to remain shiny. You can clean the oven racks in the Self-Cleaning cycle, but they will become harder to slide. (See the “Cleaning chart” in the “Caring for Your Range” section.) If you clean the racks in the Self-Cleaning cycle, place them on the 2nd and 4th rack guides. (The guides are counted from bottom to top.)
  - Heat and odors are normal during the Self-Cleaning cycle. Keep the kitchen well ventilated by opening a window or by turning on a vent hood or other kitchen vent during the cycle.
- IMPORTANT:** The health of some birds is extremely sensitive to the fumes given off during the Self-Cleaning cycle. Move birds to another closed and well ventilated room.

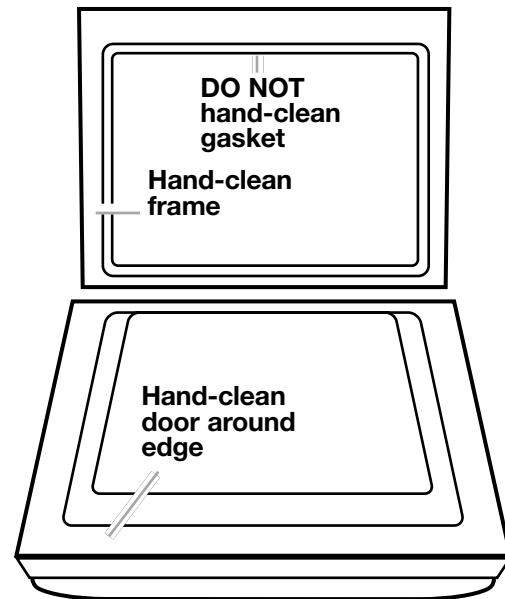

### TIPS:

- Keep the kitchen well ventilated during the Self-Cleaning cycle to help get rid of heat, odors, and smoke.
- Clean the oven before it gets heavily soiled. Cleaning a very soiled oven takes longer and results in more smoke than usual.
- Do not block the vent during the Self-Cleaning cycle. Air must move freely for best cleaning results.
- Do not leave plastic utensils on the cooktop. They may melt.
- Do not leave any foil in the oven during the Self-Cleaning cycle. Foil could burn or melt and damage the oven surface.
- The oven light will not work during the Self-Cleaning cycle.

# SETTING THE CONTROLS

**1. Press AUTO CLEAN.**

The clean indicator light will light up.  
This will automatically set a 3½-hour Self-Cleaning cycle.

**NOTE:** There will be a 30-minute cool-down ½ hour before the cycle is over.

**PRESS**



**YOU SEE**



**2. Set the cleaning time (optional).**

If you want a Self-Cleaning cycle longer or shorter than 3½ hours, use the hour and minute pads to set the cleaning time you want. Press the “up” (▲) or “down” (▼) pad(s) until a time between 2½-4½ hours shows on the display.

- Use 2½ hours for light soil.
- Use 3½-4½ hours for average to heavy soil.

**PRESS**

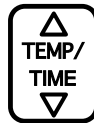

**YOU SEE**



(example for 4 ½-hour cleaning time)

**3. Start the oven.**

The on and heat indicator lights will light up.

**NOTES:**

- Make sure the door is closed all the way. If the door is open even a little, it will not lock. If the door is closed, it will lock after you press START/ENTER.
- Do not attempt to open the oven door while locking.

**PRESS**



**YOU SEE**



**4. After Self-Cleaning cycle starts:**

The door locked indicator light will light up when the oven door locks.

**5. After Self-Cleaning cycle ends and the oven reaches normal baking/roasting temperatures:**  
The clean, door locked, and on indicator lights will go out and the door unlocks.

Press OFF/CANCEL to clear the display.

**PRESS**



**YOU SEE**



## SETTING THE CONTROLS (CONT.)

**6.** After the oven cools to room temperature, wipe off any residue or ash with a damp cloth or sponge.

If needed, touch up spots with a mild abrasive cleanser or cleaning sponge.

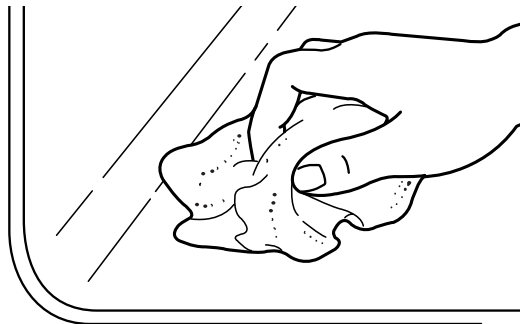

### To stop the self-cleaning cycle at any time:

If the oven temperature is above normal broiling temperatures, the Self-Cleaning cycle will start a 30-minute cool down. The clean and door locked indicator lights will stay on.

PRESS



YOU SEE



## HOW THE CYCLE WORKS

The Self-Cleaning cycle uses very high heat to burn away soil and grease. During the cycle, the oven gets much hotter than it does for normal baking or broiling. This high heat breaks up the soil or grease and burns it away.

Your oven is automatically preset for a 3½-hour Self-Cleaning cycle.

The graph at the right shows you what happens in a 3½-hour Self-Cleaning cycle. Notice that the heating stops ½ hour before the 3½-hour setting is up.

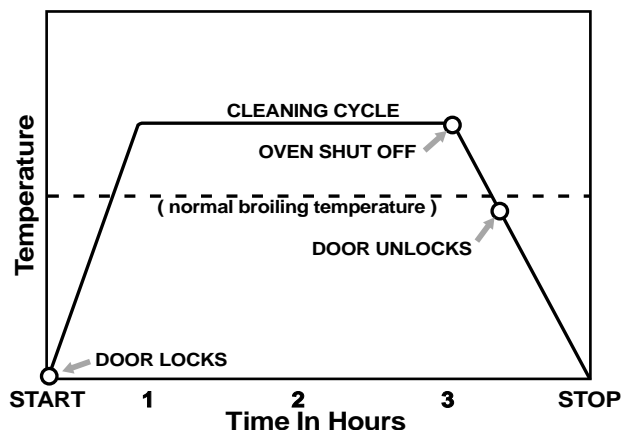

# CARING FOR YOUR RANGE



## ⚠ WARNING

### Explosion Hazard

Do not store flammable materials such as gasoline near this appliance. Doing so can result in death, explosion, or fire.

## CLEANING CHART

Before cleaning, always make sure all controls are off and the range is cool. Refer to instructions on all cleaning products before using them to clean your range.

PART	CLEANING METHOD	SPECIAL INSTRUCTIONS
<b>Control Knobs</b>	<ul style="list-style-type: none"> <li>• Soap and water</li> <li>• Dishwasher</li> </ul>	<ul style="list-style-type: none"> <li>• DO NOT use steel wool or abrasive cleaners.</li> <li>• Pull knobs straight away from control panel.</li> <li>• Wash, rinse and dry with soft cloth.</li> </ul>
<b>Control Panel</b>	<ul style="list-style-type: none"> <li>• Soap and water</li> <li>• Spray glass cleaner</li> </ul>	<ul style="list-style-type: none"> <li>• Wash, rinse and dry with soft cloth.</li> <li>• Apply spray cleaner to paper towel; do not spray directly on panel.</li> </ul>
<b>Exterior Surfaces*</b> (excluding ceramic glass cooktop, control panel and oven door glass)	<ul style="list-style-type: none"> <li>• Soap and water</li> <li>• Mild liquid cleaner</li> <li>• Spray glass cleaner</li> <li>• Non-abrasive plastic scrubbing pad</li> </ul>	<ul style="list-style-type: none"> <li>• DO NOT use abrasive or harsh cleaners like chlorine bleach, ammonia or oven cleaners.</li> <li>• Wash, rinse and dry with soft cloth.</li> <li>• Gently clean around the model and serial plate; too much scrubbing could remove the numbers.</li> </ul>
<b>Ceramic glass cooktop</b> (Models RF374PXG and RF376LXG)		<ul style="list-style-type: none"> <li>• See the “Cleaning the ceramic glass cooktop” section.</li> </ul>
<b>Coil Elements</b> (Models RF370PXG and RF370LXG)		<ul style="list-style-type: none"> <li>• DO NOT clean or immerse in water. Spatters and spills will burn off.</li> </ul>
<b>Chrome reflector bowls*</b> (Models RF370PXG and RF370LXG)	<ul style="list-style-type: none"> <li>• Light to moderate soil</li> <li>• Heavy to burned-on soils</li> </ul>	<ul style="list-style-type: none"> <li>• Soap and water</li> <li>• Non-abrasive plastic scrubbing pad</li> <li>• Dishwasher</li> <li>• Solution of 1/2 cup ammonia to 1 gallon water</li> <li>• Non-abrasive plastic scrubbing pad</li> <li>• Mild abrasive powdered cleanser or commercial oven cleaner</li> <li>• Wash, rinse and dry with soft cloth.</li> <li>• Soak bowls for 20 minutes, then scrub with plastic pad.</li> </ul>

\*When the cooktop is cool, remove all spills and clean. Food spills containing acids, such as vinegar and tomato, may affect the finish.

# CLEANING CHART (CONT.)

PART	CLEANING METHOD	SPECIAL INSTRUCTIONS
<b>Surface under cooktop</b> (Models RF370PXG and RF370LXG) <ul style="list-style-type: none"> <li>• Light to moderate soil</li> <li>• Heavy soils</li> </ul>	<ul style="list-style-type: none"> <li>• Soap and water</li> <li>• Soapy steel wool pad</li> </ul>	<ul style="list-style-type: none"> <li>• Wash, rinse and dry with soft cloth.</li> <li>• Rinse thoroughly and dry.</li> </ul>
<b>Oven door glass</b>	<ul style="list-style-type: none"> <li>• Soap and water</li> <li>• Non-abrasive plastic scrubbing pad</li> <li>• Spray glass cleaner</li> </ul>	<ul style="list-style-type: none"> <li>• Wash, rinse and dry with soft cloth.</li> <li>• Wipe with paper towel.</li> </ul>
<b>Oven cavity</b> <ul style="list-style-type: none"> <li>• Food spills containing sugar and/or milk</li> <li>• All other spills</li> </ul>	<ul style="list-style-type: none"> <li>• Soap and water</li> <li>• Self-cleaning cycle</li> </ul>	<ul style="list-style-type: none"> <li>• When oven cools, wash, rinse and dry with soft cloth or sponge.</li> <li>• See the “Using the self-cleaning cycle” section.</li> </ul>
<b>Oven racks</b>	<ul style="list-style-type: none"> <li>• Soap and water</li> <li>• Steel wool pad</li> <li>• Self-cleaning cycle</li> </ul>	<ul style="list-style-type: none"> <li>• Wash, rinse and dry.</li> <li>• Place on 2nd and 4th rack guides. Racks will discolor and become harder to slide. After cleaning, apply vegetable oil to rack guides for easier sliding.</li> </ul>
<b>Broiler pan and grid</b>	<ul style="list-style-type: none"> <li>• Soap and water</li> <li>• Steel wool pad</li> <li>• Dishwasher</li> <li>• Solution of 1/2 cup ammonia to 1 gallon water</li> <li>• Mild abrasive cleanser or commercial oven cleaner</li> </ul>	<ul style="list-style-type: none"> <li>• Wash, rinse and dry.</li> <li>• Soak for 20 minutes, then scrub with plastic scrubbing pad.</li> </ul>

## CLEANING THE CERAMIC GLASS COOKTOP (MODELS RF374PXG AND RF376LXG)

Your cooktop is designed for easy care. It has been prepolished at the factory for improved protection and easier cleaning. Foods spilled directly on the cooktop will not burn off as on open-coil elements. Because of this, you should keep the surface dust free and soil free before heating. Use the Cooktop Polishing Creme, included with your range, to clean and maintain the cooktop.

PART	WHAT TO USE	HOW TO CLEAN
<b>Ceramic glass cooktop</b>		DO NOT use steel wool, plastic cleaning pads, abrasive powdered cleansers, chlorine bleach, rust remover, ammonia, or glass cleaners with ammonia. They may damage the cooktop surface.
<b>Light to moderate soil</b>	<ul style="list-style-type: none"> <li>• Paper towel</li> <li>• Clean, damp sponge</li> </ul>	Wipe as soon as Hot Surface Indicator Light goes off. Rinse thoroughly and dry.
<b>Heavy soil, dark streaks, specks, and discoloration</b>	<ul style="list-style-type: none"> <li>• Cooktop Polishing Creme*</li> <li>• Non-abrasive cleanser</li> </ul>	Rub into soil using damp paper towel. Rinse and dry.
<b>Burned-on soils</b>	<ul style="list-style-type: none"> <li>• Cooktop Polishing Creme*</li> <li>• Razor scraper in a holder</li> </ul>	Rub creme into soil using paper towel. Reapply creme to remaining spots. Hold razor scraper as flat to surface as possible, scrape spots. Polish entire cooktop with creme and paper towel. Rinse and dry. <b>Store razor blades out of reach of children.</b>
<b>Sugary spills</b> (jellies, candy syrups)	<ul style="list-style-type: none"> <li>• Paper towel</li> <li>• Clean, damp sponge</li> </ul>	Wipe while ceramic glass surface is warm. Rinse thoroughly and dry.
<b>Metal marks from copper, aluminum pans</b>	<ul style="list-style-type: none"> <li>• Cooktop Polishing Creme*</li> </ul>	Before heating cooktop again, rub into area using damp paper towel. Rinse and dry.
<b>Tiny scratches or abrasions</b>	<ul style="list-style-type: none"> <li>• Cooktop Polishing Creme*</li> </ul>	To prevent scratches and abrasions, use the Cooktop Polishing Creme regularly. Scratches and abrasions do not affect cooking performance. After many cleanings, they will become less visible.

**NOTE:** Always wipe your cooktop with clean water and dry it well after using the cleanser to prevent streaking or staining.

\*To order additional Cooktop Polishing Creme (Part No. 3184477), call 1-800-253-1301. You will hear a recording. Follow the steps to place an order.

# COIL ELEMENTS AND REFLECTOR BOWLS (MODELS RF370PXG AND RF370LXG)

## Removing

1. Make sure all coil elements are off and cool before removing coil elements and reflector bowls.

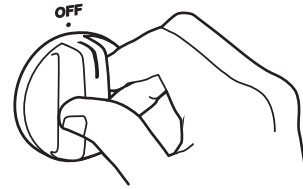

2. Push in the edge of the coil element, opposite the receptacle. Then lift it just enough to clear the reflector bowl.

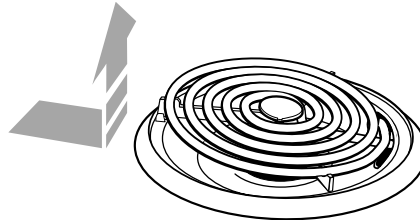

3. Pull the coil element straight away from the receptacle.

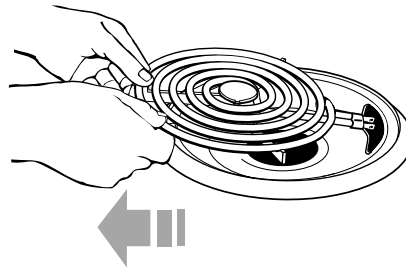

4. Lift out the reflector bowl. See the "Cleaning chart" earlier in this section for cleaning instructions.



## Replacing

1. Make sure all coil elements are off and cool before replacing coil elements and reflector bowls.

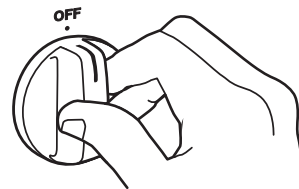

2. Line up openings in the reflector bowl with the coil element receptacle.



## COIL ELEMENTS AND REFLECTOR BOWLS (MODELS RF370PXG AND RF370LXG) (CONT.)

3. Hold the coil element as level as possible with the terminal just started into the receptacle. Push the coil element terminal into the receptacle.

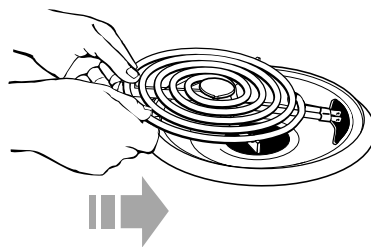

4. When the terminal is pushed into the receptacle as far as it will go, push down the edge of the coil element opposite the receptacle.

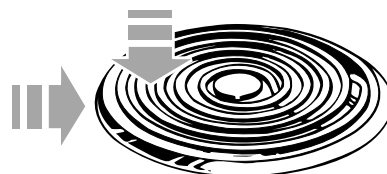

**NOTE:** Reflector bowls reflect heat back to the cookware on the coil elements. They also help catch spills. When they are kept clean, they reflect heat better and look new longer.

If a reflector bowl changes color, some of your cookware may not be flat enough, or some may be too large for the coil element. In either case, some of the heat that's meant to go into or around cookware goes down and heats the reflector bowl. This extra heat can cause it to change color.

## LIFT-UP COOKTOP (MODELS RF370PXG AND RF370LXG)

**NOTE:** Do not drop the cooktop. Damage could result to the porcelain and the cooktop frame.

1. Lift the front of the cooktop at both front corners until the support rods lock into place.
2. Wipe the surface under the cooktop with warm, soapy water and a sponge. Use a soapy steel-wool pad on heavily soiled areas.
3. To lower the cooktop, lift the cooktop from both sides while pressing the support rods back to unlock them. Lower the cooktop into place.

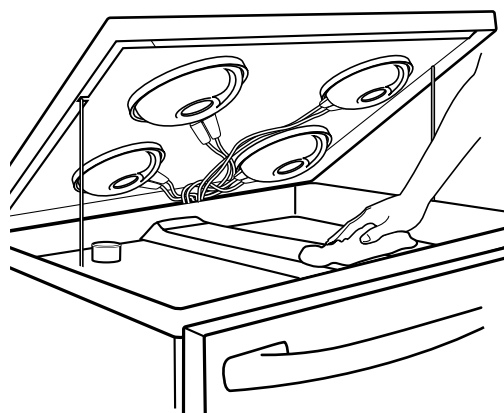

## REMOVING THE OVEN DOOR

For normal use of your range, you do not need to remove the door. However, if you find it necessary to remove the door, follow the instructions in this section.

**NOTE:** The oven door is heavy.

### Before removing the door:

1. Use a putty knife or screwdriver and insert it at the bottom corner of the door stop clip.
2. Pry door stop clip free and remove from front frame hinge slot. Take care not to scratch porcelain.
3. Repeat procedure for other door stop clip.

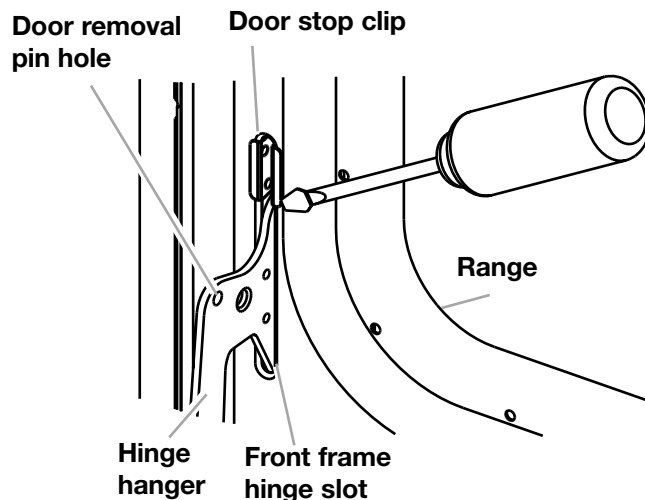

### To remove:

1. Open the oven door. Insert door removal pins, included with your range, into both hinge hangers. **Do not remove the pins while the door is removed from the range.**

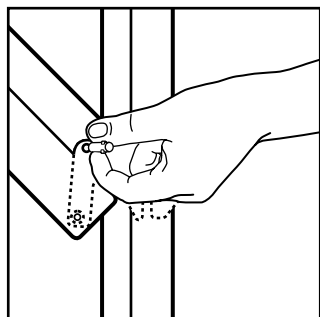

2. Carefully close the door until it rests against the door removal pins.

3. Grasp the door on the sides with your fingers on the front of the door and your thumbs on the inside surface.

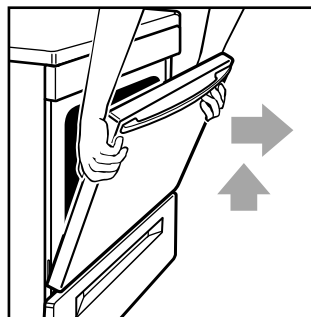

4. Pull door straight up, then toward you. Hinge hangers will slide out of front frame hinge slot.

### To replace:

**NOTE:** The door removal pins you inserted must still be in both hinges.

1. Grasp the door on the sides with your fingers on the front of the door and your thumbs on the inside surface.

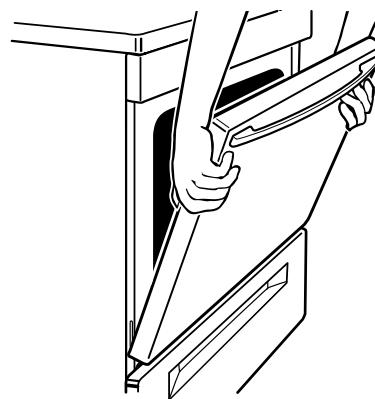

## REMOVING THE OVEN DOOR (CONT.)

2. Hold oven door so that the top edge of each hinge hanger is horizontal. Insert hinge hangers into the front frame hinge slots.
  3. Rotate top of door toward range. Slide hinge hangers down onto front frame support pins.
- NOTE:** Make sure the hinge hangers are fully seated and engaged on the support pins.
4. Insert the door stop clip with the angular surface at the top of the frame hinge slot, then push in the bottom of the clip until flanges are flush with the front frame.
  5. Open the door completely and remove the door removal pins. Save door removal pins for future use.
  6. Close the door.

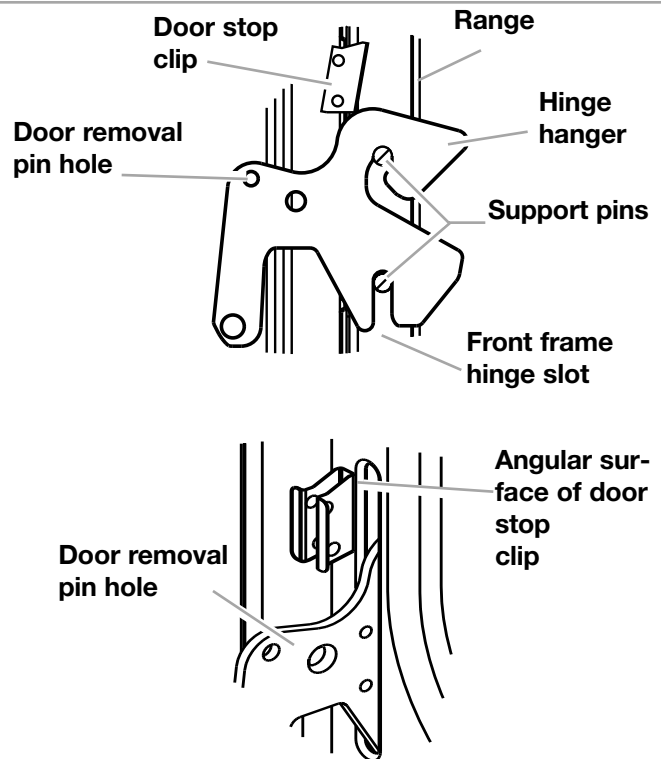

## THE OVEN LIGHT

The oven light will come on when you open the oven door.

### To turn the light on or off when the oven door is closed:

- Push the oven light switch on the backguard.

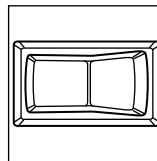

### To replace the oven light:

1. Unplug range or disconnect power.
2. Remove the glass bulb cover in the back of the oven by turning it counterclockwise.

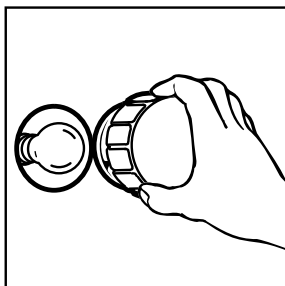

3. Remove the light bulb from its socket. Replace the bulb with a 40-watt appliance bulb.

4. Replace the bulb cover by turning it clockwise.

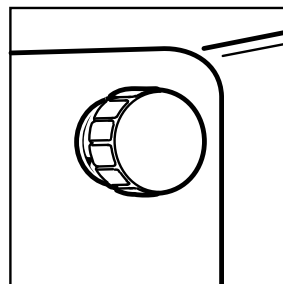

5. Plug in range or reconnect power.

**NOTE:** The oven light will not work during the Self-Cleaning cycle.

# TROUBLESHOOTING

Most cooking problems often are caused by little things you can find and fix without tools of any kind. Check the lists below and on the next page before calling for assistance or service. If you still need help, see “Requesting Assistance or Service” on page 38.

## RANGE DOES NOT WORK

PROBLEM	CAUSE
Nothing works	<ul style="list-style-type: none"><li>● The range is not plugged into a properly grounded live outlet with the proper voltage. (See Installation Instructions.)</li><li>● You have blown a household fuse or tripped a circuit breaker.</li><li>● The control knob is not set correctly. Push in the control knobs before turning them.</li></ul>
The oven does not work	<ul style="list-style-type: none"><li>● You have not set the electronic control correctly. Refer to setting the electronic oven control section. (See pages 17-19.)</li></ul>
The surface cooking areas will not work	<ul style="list-style-type: none"><li>● You have blown a household fuse or tripped a circuit breaker.</li><li>● The coil elements are not plugged in all the way (Models RF370PXG and RF370LXG). (See “Replacing” on pages 32-33.)</li><li>● You have not set the control knobs correctly. Push the control knobs in before turning them to a setting.</li></ul>

## WHEN SELF-CLEANING YOUR OVEN

PROBLEM	CAUSE
The Self-Cleaning cycle will not work	<ul style="list-style-type: none"><li>● You did not press START/ENTER.</li><li>● The door is not closed all the way.</li></ul>

## COOKING RESULTS

PROBLEM	SOLUTION
Cookware not level on cooktop (Check to see if liquids are level in cookware)	<ul style="list-style-type: none"> <li>● Level the range. (See the Installation Instructions.)</li> <li>● Insert coil correctly.</li> <li>● Use cookware with a flat bottom.</li> </ul>
Excessive heat on cooktop in areas around cookware	<ul style="list-style-type: none"> <li>● Choose cookware the same size or slightly larger than the element.</li> </ul>
The oven temperature seems too low or too high	<ul style="list-style-type: none"> <li>● Adjust the oven temperature control. (See “Adjusting the oven temperature control” section.)</li> </ul>
Slow baking or roasting	<ul style="list-style-type: none"> <li>● Increase baking or roasting time.</li> <li>● Increase temperature 25° F.</li> <li>● Preheat oven to selected temperature before placing food in when preheating is recommended.</li> <li>● Choose bakeware that will allow 2 inches of air space around all sides.</li> <li>● Open oven door to check food when timer signals shortest time suggested in recipe.</li> <li>● Oven peeking can make cooking times longer.</li> </ul>
Baked items too brown on bottom	<ul style="list-style-type: none"> <li>● Preheat oven to selected temperature before placing food in oven.</li> <li>● Choose bakeware that will allow 2 inches of air space around all sides.</li> <li>● Position rack higher in oven.</li> <li>● Decrease oven temperature 15° to 25° F.</li> </ul>
Unevenly baked items	<ul style="list-style-type: none"> <li>● Level the range.</li> <li>● Bake in center of oven with 2 inches of space around each pan.</li> <li>● Check to make sure batter is level in pan.</li> </ul>
Crust edge browns before pie is done	<ul style="list-style-type: none"> <li>● Shield edge with foil.</li> </ul>

## DISPLAY MESSAGES

PROBLEM	CAUSE
The display is showing “PF”	<ul style="list-style-type: none"> <li>● There has been a power failure. Press OFF/CANCEL to clear the display, then reset the clock. (See page 15.)</li> </ul>
“F” followed by a number shows on the display	<ul style="list-style-type: none"> <li>● Press OFF/CANCEL to clear the display. If an “F” code appears again, call for service. (See “If You Need Assistance or Service” on page 39.)</li> </ul>

If none of these items are causing your problem, see “Requesting Assistance or Service” on page 38.

# REQUESTING ASSISTANCE OR SERVICE

To avoid unnecessary service calls, please check the “Troubleshooting” section. It may save you the cost of a service call. If you still need help, follow the instructions below.

## IF YOU NEED ASSISTANCE OR SERVICE

### Call the Whirlpool Consumer Assistance



Center toll free at 1-800-253-1301. Our consultants are available to assist you.

When calling:

Please know the purchase date, and the complete model and serial number of your appliance (see the “A Note to You” section). This information will help us better respond to your request.

### Our consultants provide assistance with:

- Features and specifications on our full line of appliances
- Installation information
- Use and maintenance procedures

- Accessory and repair parts sales
- Specialized customer assistance (Spanish speaking, hearing impaired, limited vision, etc.)
- Referrals to local dealers, service companies, and repair parts distributors

**Whirlpool service technicians** are trained to fulfill the product warranty and provide after-warranty service, anywhere in the United States.

To locate the authorized Whirlpool service company in your area, you can also look in your telephone directory Yellow Pages.

## IF YOU NEED REPLACEMENT PARTS

If you need to order replacement parts, we recommend that you only use FSP® factory authorized parts. FSP replacement parts will fit right and work right, because they are made to the same exacting specifications used to build every new WHIRLPOOL® appliance.

To locate FSP replacement parts in your area, call our Consumer Assistance Center telephone number or your nearest authorized service center.

## FOR FURTHER ASSISTANCE

If you need further assistance, you can write to Whirlpool with any questions or concerns at:

Whirlpool Brand Home Appliances  
Consumer Assistance Center  
c/o Correspondence Dept.  
2000 North M-63  
Benton Harbor, MI 49022-2692

Please include a daytime phone number in your correspondence.

# INDEX

TOPIC	PAGE	TOPIC	PAGE
ANTI-TIP BRACKET .....	25	FEATURES .....	6, 7
ASSISTANCE .....	38	LIFT-UP COOKTOP .....	33
BAKING		MODEL AND SERIAL NUMBER .....	2
Aluminum foil .....	13	OVEN DOOR .....	34, 35
Bakeware .....	13	OVEN LIGHT .....	35
Pans .....	12	OVEN TEMPERATURE	
Racks .....	12, 17	Adjusting .....	19, 20
Setting cycle.....	17	Setting .....	17, 22
Tips.....	19	OVEN VENT .....	24
BROILING		PANS .....	12
Grid.....	23	PARTS .....	6, 7
Guidelines.....	23	RACKS.....	12, 17
Pan .....	21, 23	ROASTING	
Rack positions .....	23	Pans .....	12
Setting cycle.....	22	Racks .....	12, 17
CLEANING		Setting cycle.....	17
Broiler pan and grid .....	30	Tips.....	18
Ceramic glass cooktop .....	29, 31	SAFETY .....	3, 4, 5
Coil elements .....	29, 32, 33	SELF-CLEANING CYCLE	
Control knobs.....	29	Before you start .....	26
Control panel .....	29	How the cycle works .....	28
Exterior surfaces .....	29	Setting the controls .....	27
Oven cavity .....	30	Stopping the cycle .....	28
Oven door glass.....	30	Tips.....	26
Oven racks .....	30	SERVICE .....	38
Reflector bowls .....	29, 32, 33	STORAGE DRAWER .....	25
Self-cleaning cycle.....	26	SURFACE COOKING AREAS	
Surface under cooktop .....	30	Ceramic glass cooktop .....	11
CONTROL PANEL		Coil element markers .....	6
Coil element markers .....	6	Control knobs.....	8, 29
Control knobs.....	8	Control setting guide .....	8
Surface cooking area markers .....	7	Hot surface indicator lights .....	7, 11
Surface heating indicator light .....	6, 7	Surface cooking area markers .....	7
COOKWARE		Surface heating indicator light .....	6, 7
Canning .....	9	TROUBLESHOOTING .....	36, 37
Materials.....	10	WARRANTY .....	40
Tips.....	10		
ELECTRONIC OVEN CONTROL			
Canceling .....	16		
Clock .....	15		
Control lock .....	14		
Display .....	14		
Indicator lights .....	14		
Minute timer .....	15		
Starting.....	16		

# WARRANTY

## WHIRLPOOL® ELECTRIC RANGE

LENGTH OF WARRANTY	WHIRLPOOL WILL PAY FOR
<b>FULL ONE-YEAR WARRANTY</b> FROM DATE OF PURCHASE	FSP® replacement parts and repair labor to correct defects in materials or workmanship. Service must be provided by an authorized Whirlpool service company.
<b>FULL FIVE-YEAR WARRANTY</b> FROM DATE OF PURCHASE	Ceramic glass cooktop only: FSP replacement parts and repair labor for CLEANTOP® ceramic glass cooktop. Whirlpool warrants that: <ul style="list-style-type: none"> <li>-The ceramic glass cooktop will not discolor</li> <li>-The ceramic glass cooktop pattern will not wear off</li> <li>-The rubber seal between the ceramic glass cooktop and porcelain edge will not crack</li> <li>-The ceramic glass cooktop will not crack due to thermal shock</li> <li>-The surface unit elements will not burn out</li> </ul>
<b>WHIRLPOOL WILL NOT PAY FOR</b>	
<p><b>A.</b> Service calls to:</p> <ol style="list-style-type: none"> <li>1. Correct the installation of your range.</li> <li>2. Instruct you how to use your range.</li> <li>3. Replace house fuses or correct house wiring.</li> <li>4. Replace owner-accessible light bulbs.</li> </ol> <p><b>B.</b> Repairs when your range is used in other than normal, single-family household use.</p> <p><b>C.</b> Pickup and delivery. Your range is designed to be repaired in the home.</p> <p><b>D.</b> Damage to your range caused by accident, misuse, fire, flood, acts of God, or use of products not approved by Whirlpool.</p> <p><b>E.</b> Repairs to CLEANTOP ceramic glass cooktop if it has not been cared for as recommended in this Use and Care Guide.</p> <p><b>F.</b> Repairs to parts or systems resulting from unauthorized modifications made to the appliance.</p>	

4/98

**WHIRLPOOL CORPORATION SHALL NOT BE LIABLE FOR INCIDENTAL OR CONSEQUENTIAL DAMAGES.**

Some states do not allow the exclusion or limitation of incidental or consequential damages, so this exclusion or limitation may not apply to you. This warranty gives you specific legal rights, and you may also have other rights which vary from state to state.

**Outside the United States, a different warranty may apply. For details, please contact your authorized Whirlpool dealer.**

If you need service, first see the "Troubleshooting" section of this book. After checking "Troubleshooting," additional help can be found by checking the "Requesting Assistance or Service" section, or by calling the Whirlpool Consumer Assistance Center telephone number, **1-800-253-1301**, from anywhere in the U.S.A.